

SOG



WORK BOOK

SPRING 2019



ABOUT SOG

When we started 32 years ago with the S1 Bowie, our philosophy was to build the best situation-ready gear for professionals and everyday users. Inspired by the knives carried by the Vietnam-era Special Forces unit, MACV-SOG, the S1 drew its inspiration from the people who carried it. When it hit the market in 1986, it sold out. That's when we knew we had to keep going. We followed it up with knives like the SCUBA and Trident fixed blades, designed for the same elite military users we drew inspiration from.

We didn't stop there, and we set our sights on bringing the same quality of tools to more users.

We went into folding knives, then multi-tools, illumination, and packs. And we're still looking for opportunities, and always aiming to create the best gear possible for whatever situation you may encounter.

Sometimes that situation is realizing you need to strip some wires. Other times it means prepping a campsite in dark. And yet other times it means cutting away clothing in an emergency situation. The world throws a lot of curveballs every day and it's not going to wait for us to be ready. Perpetration, planning, and anticipation are what we arm ourselves with each day. And it's what guides our designs, to make the gear that enables you to tackle anything life throws your way.

A lot may have changed since the 80's. But our philosophy hasn't. Stay ready.

MULTI-TOOLS

SOG Multi-tools embody our drive to make gear that allows user to be well equipped with the right tools for the job. We pack an optimal number of components into each of our multi-tools, optimized for the mission in hand.

With industry-leading innovations, like Compound Leverage that ensures a smooth opening and superior gripping strength, we aim to provide multitools that deliver not only in practical utility, but in performance also. Like our SYNC line that can easily be worn as a belt buckle, or our Batons designed for sleek and understated urban carry.

However you work, however you carry, SOG has a multi-tool to suit your mission.



BATON Q4 MULTI-TOOL

22
TOOLS

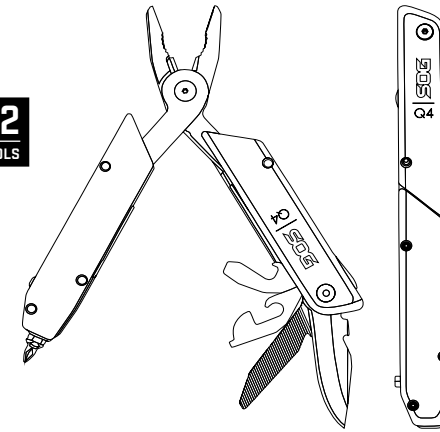

LENGTH 7.00in / 178mm WEIGHT 6.00oz / 170g
HANDLE 6061-T6 ALUMINUM STEEL 5CR15MOV

AVAILABLE CONFIGURATIONS	PART #	DEALER
Baton Q4 + Hex Bit Kit - Synthetic Sheath	ID1031-CP	005997

NOTES:

BATON Q3 MULTI-TOOL

13
TOOLS

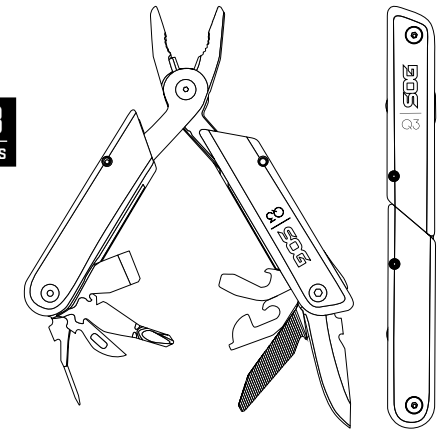

LENGTH 6.60in / 168mm WEIGHT 6.00oz / 170g
HANDLE 6061-T6 ALUMINUM STEEL 5CR15MOV

AVAILABLE CONFIGURATIONS	PART #	DEALER
Baton Q3	ID1021-CP	004663

NOTES:

BATON Q2 MULTI-TOOL

4
TOOLS

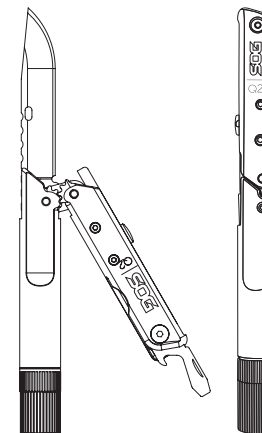

LENGTH 6.30in / 160mm WEIGHT 3.00oz / 85g
HANDLE 6061-T6 ALUMINUM STEEL 5CR15MOV

AVAILABLE CONFIGURATIONS	PART #	DEALER
Baton Q2	ID1011-CP	003330

NOTES:

BATON Q1 MULTI-TOOL

4
TOOLS

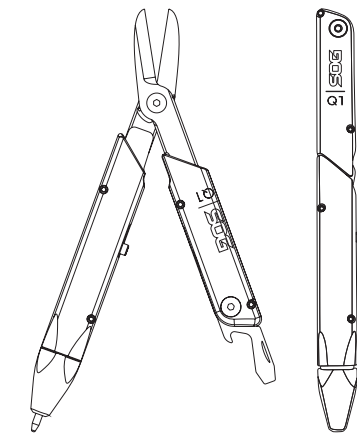

LENGTH 6.00in / 142mm WEIGHT 2.40oz / 68g
HANDLE 6061-T6 ALUMINUM STEEL 5CR15MOV

AVAILABLE CONFIGURATIONS	PART #	DEALER
Baton Q1	ID1001-CP	002663

NOTES:

POWERLOCK W/V-CUTTER MULTI-TOOL

18
TOOLS

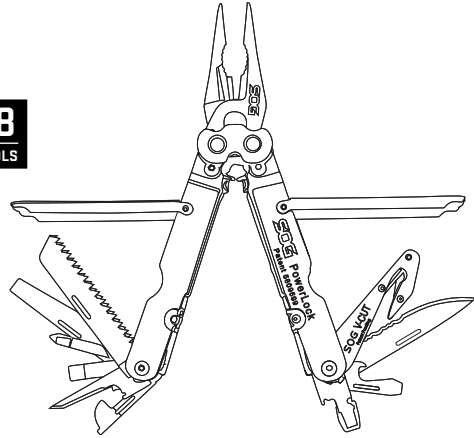

LENGTH 7.00in / 178mm **WEIGHT** 9.60oz / 272g
HANDLE STAINLESS STEEL **STEEL** 420 STAINLESS

AVAILABLE CONFIGURATIONS	PART #	DEALER
PowerLock EDD w/V-Cutter - Black Oxide Nylon Sheath	B63N-CP	006063
PowerLock w/V-Cutter - Nylon Sheath	S62N-CP	005530

NOTES:

POWERLOCK MULTI-TOOL

18
TOOLS

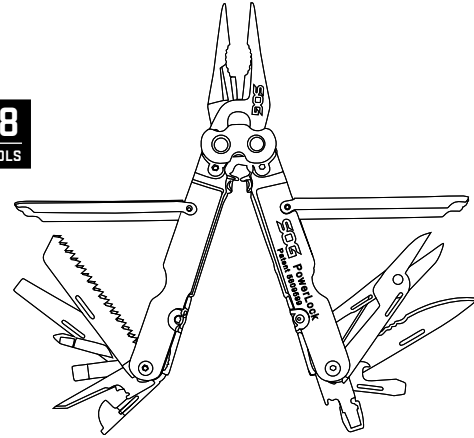

LENGTH 7.00in / 178mm **WEIGHT** 9.60oz / 272g
HANDLE STAINLESS STEEL **STEEL** 420 STAINLESS

AVAILABLE CONFIGURATIONS	PART #	DEALER
PowerLock EDD - Black Oxide Nylon Sheath	B61N-CP	006063
PowerLock - Nylon Sheath	S60N-CP	005530

NOTES:

POWERACCESS DELUXE MULTI-TOOL

21
TOOLS

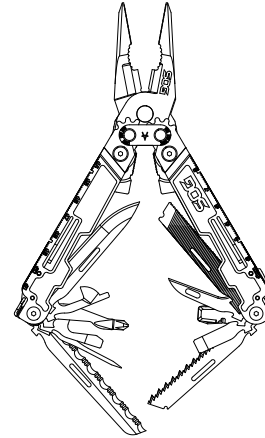

LENGTH 6.90in / 173mm **WEIGHT** 8.70oz / 247g
HANDLE STAINLESS STEEL **STEEL** 5CR15MOV

AVAILABLE CONFIGURATIONS	PART #	DEALER
PowerAccess Deluxe + Hex Bit Kit - Fabric Sheath	PA2001-CP	004663

NOTES:

POWERACCESS MULTI-TOOL

18
TOOLS

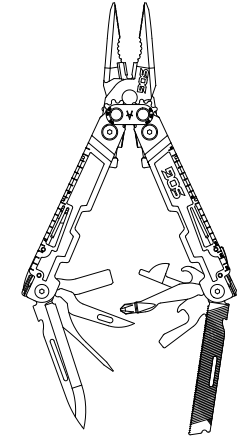

LENGTH 5.90in / 150mm **WEIGHT** 5.90oz / 167g
HANDLE STAINLESS STEEL **STEEL** 5CR15MOV

AVAILABLE CONFIGURATIONS	PART #	DEALER
PowerAccess	PA1001-CP	003663

NOTES:

POWERASSIST MULTI-TOOL

16
TOOLS

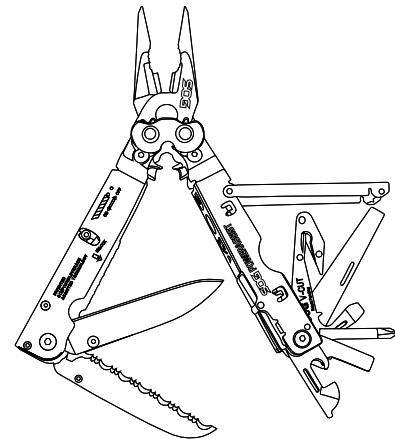

LENGTH 7.00in / 178mm **WEIGHT** 9.60oz / 272g
HANDLE STAINLESS STEEL **STEEL** 420 STAINLESS

AVAILABLE CONFIGURATIONS	PART #	DEALER
PowerAssist - Black Oxide Nylon Sheath	B66N-CP	006130
PowerAssist - Nylon Sheath	S66N-CP	005797

NOTES:

POWERPLAY MULTI-TOOL

18
TOOLS

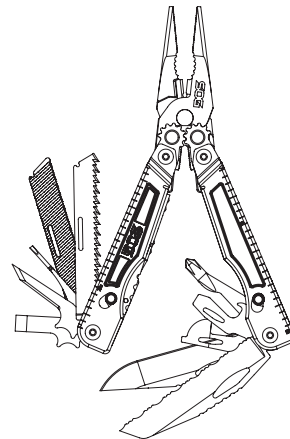

LENGTH 6.25in / 159mm **WEIGHT** 8.10oz / 230g
HANDLE STAINLESS STEEL **STEEL** 5CR15MOV

AVAILABLE CONFIGURATIONS	PART #	DEALER
PowerPlay + Hex Bit Kit - Nylon Sheath	PX1001N-CP	004663

NOTES:

POWERPINT MULTI-TOOL

19
TOOLS

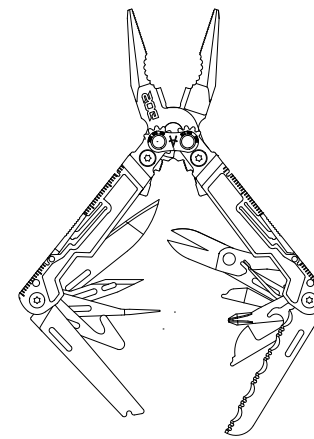

LENGTH 5.10in / 127mm **WEIGHT** 4.20oz / 119g
HANDLE STAINLESS STEEL **STEEL** 5CR15MOV

AVAILABLE CONFIGURATIONS	PART #	DEALER
PowerPint	PP1001-CP	002997

NOTES:

POWERLITRE MULTI-TOOL

18
TOOLS

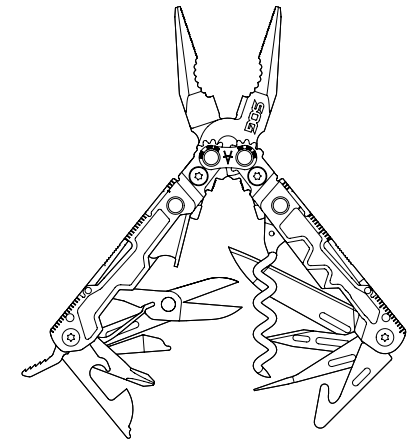

LENGTH 5.10in / 127mm **WEIGHT** 4.60oz / 130g
HANDLE STAINLESS STEEL **STEEL** 5CR15MOV

AVAILABLE CONFIGURATIONS	PART #	DEALER
PowerLitre	PL1001-CP	003663

NOTES:

SWITCHPLIER 2.0 MULTI-TOOL

12
TOOLS

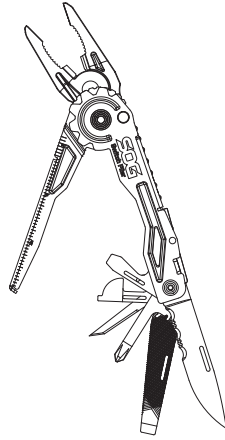

LENGTH 6.10in / 155mm WEIGHT 6.30oz / 179g
HANDLE STAINLESS STEEL STEEL 420 STAINLESS

AVAILABLE CONFIGURATIONS	PART #	DEALER
SwitchPlier 2.0	SWP1001-CP	003997

NOTES:

SNIPPET MULTI-TOOL

10
TOOLS

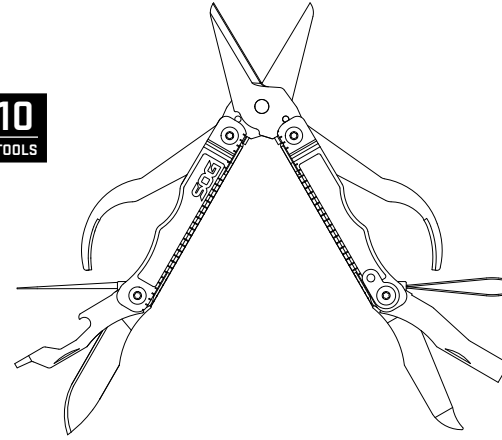

LENGTH 4.42in / 112mm WEIGHT 2.00oz / 57g
HANDLE STAINLESS STEEL STEEL 5CR15MOV

AVAILABLE CONFIGURATIONS	PART #	DEALER
Snippet	23-32-01-41	001663

NOTES:

SYNC I MULTI-TOOL

11
TOOLS

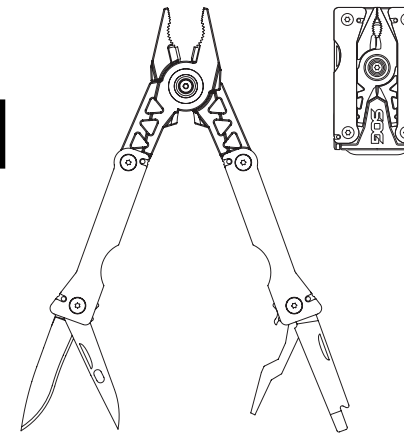

LENGTH 4.40in / 112mm WEIGHT 4.80oz / 74g
HANDLE STAINLESS STEEL STEEL 5CR15MOV

AVAILABLE CONFIGURATIONS	PART #	DEALER
Sync I	SN1001-CP	003330

NOTES:

SYNC II MULTI-TOOL

11
TOOLS

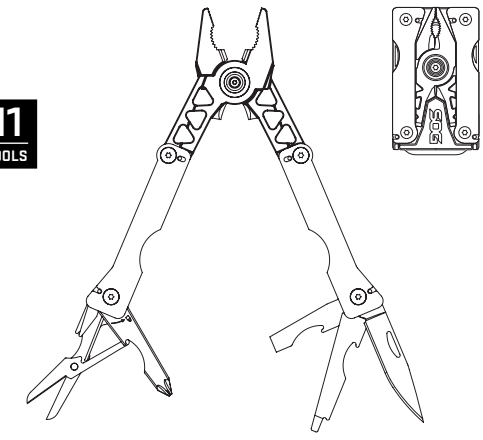

LENGTH 5.80in / 147mm WEIGHT 8.90oz / 141g
HANDLE STAINLESS STEEL STEEL 5CR15MOV

AVAILABLE CONFIGURATIONS	PART #	DEALER
Sync II	SN1011-CP	003997

NOTES:

MICRO TOOLCLIP MULTI-TOOL

9
TOOLS

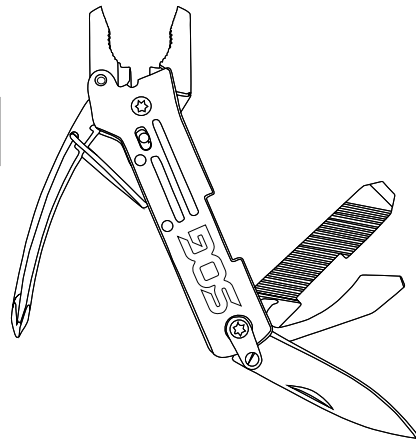

LENGTH 3.90in / 99mm WEIGHT 3.30oz / 94g
HANDLE GRN STEEL 7CR17MOV

AVAILABLE CONFIGURATIONS	PART #	DEALER
Micro ToolClip	TC1001-CP	001463

NOTES:

CROSSCUT MULTI-TOOL

8
TOOLS

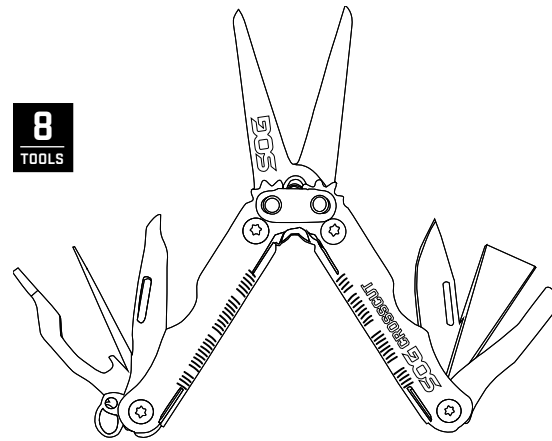

LENGTH 4.00in / 102mm WEIGHT 1.70oz / 48g
HANDLE STAINLESS STEEL STEEL 5CR15MOV

AVAILABLE CONFIGURATIONS	PART #	DEALER
CrossCut	CC51-CP	001197

NOTES:

SYNC I TRAVELER MULTI-TOOL

10
TOOLS

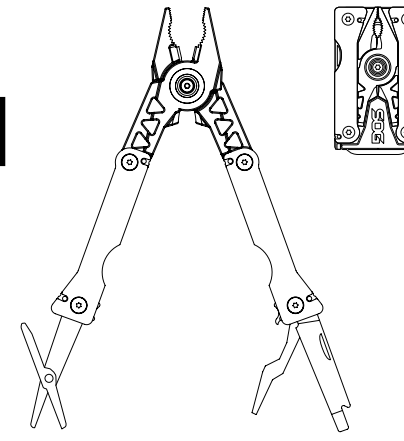

LENGTH 4.40in / 112mm WEIGHT 4.80oz / 74g
HANDLE STAINLESS STEEL STEEL 5CR15MOV

AVAILABLE CONFIGURATIONS	PART #	DEALER
Sync I Traveler - Black	SN1002-CP	003330

NOTES:

SYNC II TRAVELER MULTI-TOOL

10
TOOLS

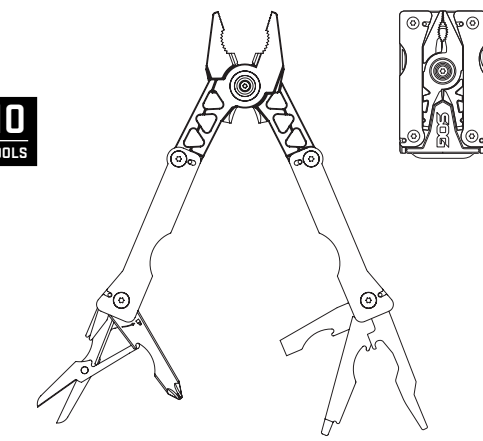

LENGTH 5.80in / 147mm WEIGHT 8.90oz / 141g
HANDLE STAINLESS STEEL STEEL 5CR15MOV

AVAILABLE CONFIGURATIONS	PART #	DEALER
Sync II Traveler - Black	SN1012-CP	003997

NOTES:

HEX BIT ACCESSORY KIT ACCESSORY

13
TOOLS



LENGTH 4.32in / 110mm **WEIGHT** 2.70oz / 77g

BIT CARRIER HARD MOLDED NYLON

BITS Phillips #1, #2, #3 Flathead #3, #5, #7
Star-drive T6, T8, T10, T20 Hex 1.5mm, 2mm

AVAILABLE CONFIGURATIONS	PART #	DEALER
Hex Bit Accessory Kit	HXB-01	000997

NOTES:



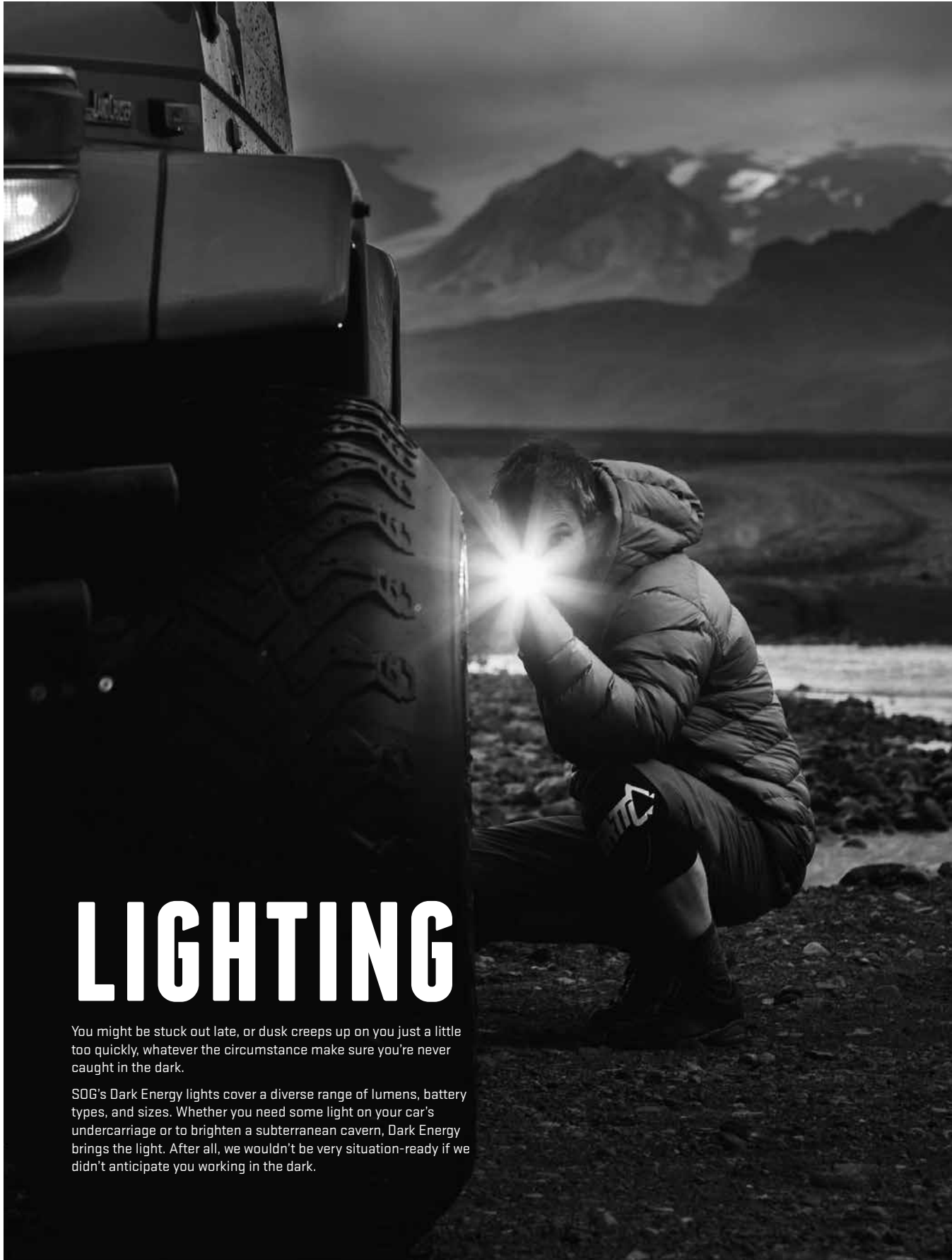

LIGHTING

You might be stuck out late, or dusk creeps up on you just a little too quickly, whatever the circumstance make sure you're never caught in the dark.

SOG's Dark Energy lights cover a diverse range of lumens, battery types, and sizes. Whether you need some light on your car's undercarriage or to brighten a subterranean cavern, Dark Energy brings the light. After all, we wouldn't be very situation-ready if we didn't anticipate you working in the dark.

DE-06 ILLUMINATION

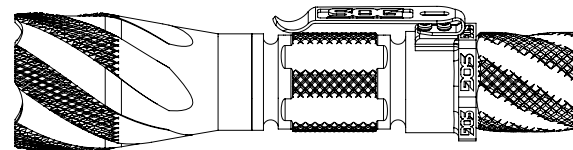

LENGTH 6.00in / 152mm **WEIGHT** 6.60oz / 187g **MAX LUMENS** 687
MAX RUNTIME 97.73 HOURS **BATTERY TYPE** RECHARGABLE 18650

AVAILABLE CONFIGURATIONS	PART #	DEALER
Dark Energy	DE-06	009663

NOTES:

DE-03 ILLUMINATION

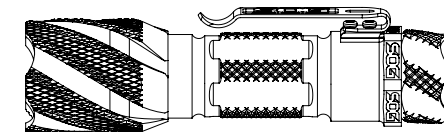

LENGTH 4.50in / 114mm **WEIGHT** 3.80oz / 108g **MAX LUMENS** 128
MAX RUNTIME 67.3 HOURS **BATTERY TYPE** ONE AA

AVAILABLE CONFIGURATIONS	PART #	DEALER
Dark Energy	DE-03	003197

NOTES:

DE-02 ILLUMINATION

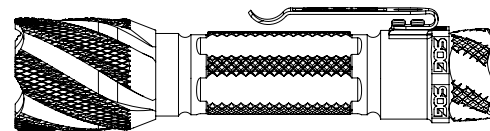

LENGTH 5.10in / 130mm **WEIGHT** 4.10oz / 116g **MAX LUMENS** 263
MAX RUNTIME 89 HOURS **BATTERY TYPE** TWO CR-123A

AVAILABLE CONFIGURATIONS	PART #	DEALER
Dark Energy	DE-02	005530

NOTES:

DE-01 ILLUMINATION

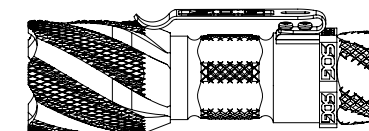

LENGTH 3.80in / 97mm **WEIGHT** 3.00oz / 85g **MAX LUMENS** 188
MAX RUNTIME 22 HOURS **BATTERY TYPE** ONE CR-123A

AVAILABLE CONFIGURATIONS	PART #	DEALER
Dark Energy	DE-01	004463

NOTES:

FOLDING KNIVES

Right next to your phone, keys, and wallet, your folding knife is something that's constantly by your side. Your folder is the most important EDC you can have, that's why we design our knives for everyday use, not for collecting dust. Even our elegant knives like the Kiku folders are built for taking on the toughest jobs you can throw at them. While our simpler knives, like the Fielder, have options like assisted opening.

When it comes to folding knives, SOG aims to deliver a wide selection of folders to make you situation-ready, for whatever that situation may be.



TOMCAT 3.0 FOLDING KNIFE



BLADE 3.75in / 95mm **LENGTH** 8.65in / 220mm
WEIGHT 6.50oz / 184g **HANDLE** RUBBER **STEEL** VG-10

AVAILABLE CONFIGURATIONS	PART #	DEALER
Tomcat 3.0 - Satin	S95-N	013530

NOTES:

VISION ARC FOLDING KNIFE

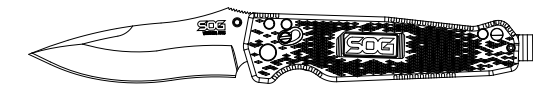

BLADE 3.80in / 97mm **LENGTH** 8.40in / 213mm
WEIGHT 4.20oz / 119g **HANDLE** GRN **STEEL** VG-10

AVAILABLE CONFIGURATIONS	PART #	DEALER
Vision Arc - Black TiNi	VS03-BX	008663

NOTES:

SPEC ARC FOLDING KNIFE



BLADE 4.00in / 102mm **LENGTH** 8.80in / 224mm
WEIGHT 4.40oz / 125g **HANDLE** GRN **STEEL** VG-10

AVAILABLE CONFIGURATIONS	PART #	DEALER
Spec Arc - Bead Blasted	SE15-BX	007997

NOTES:

PENT ARC FOLDING KNIFE

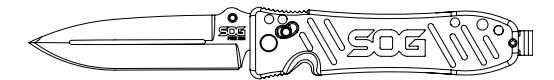

BLADE 4.00in / 102mm **LENGTH** 8.80in / 224mm
WEIGHT 4.40oz / 125g **HANDLE** GRN **STEEL** VG-10

AVAILABLE CONFIGURATIONS	PART #	DEALER
Pent Arc - Bead Blasted	PE15-BX	007997

NOTES:

VULCAN FOLDING KNIFE

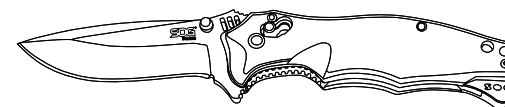

BLADE 3.50in / 89mm **LENGTH** 8.38in / 213mm
WEIGHT 5.00oz / 142g **HANDLE** GRN **STEEL** VG-10

AVAILABLE CONFIGURATIONS	PART #	DEALER
Vulcan - Satin	VL-01	009130
Vulcan Tanto - Satin	VL-03	010130

Vulcan - Black TiNi	VL-11	009797
---------------------	-------	--------

NOTES:

VULCAN MINI FOLDING KNIFE

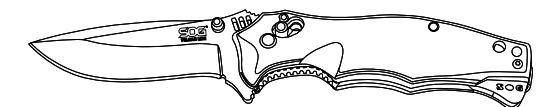

BLADE 3.00in / 76mm **LENGTH** 7.35in / 187mm
WEIGHT 3.40oz / 96g **HANDLE** GRN **STEEL** VG-10

AVAILABLE CONFIGURATIONS	PART #	DEALER
Vulcan Mini - Satin	VL02-CP	007863

NOTES:

ULTRA C-TI FOLDING KNIFE

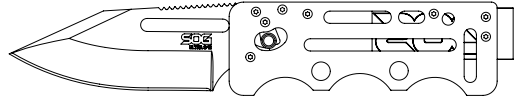

BLADE 2.80in / 71mm **LENGTH** 6.20in / 157mm
WEIGHT 1.30oz / 37g **HANDLE** CARBON FIBER **STEEL** VG-10

AVAILABLE CONFIGURATIONS	PART #	DEALER
Ultra C-Ti - Bead Blasted	SOGAC79-BX	006663

NOTES:

TARGA FOLDING KNIFE

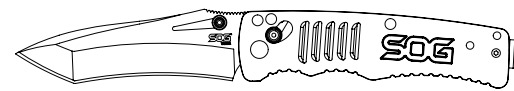

BLADE 3.50in / 89mm **LENGTH** 7.85in / 201mm
WEIGHT 3.10oz / 88g **HANDLE** STAINLESS STEEL **STEEL** VG-10

AVAILABLE CONFIGURATIONS	PART #	DEALER
Targa - Black	TG1002-BX	006663
Targa - Satin	TG1001-BX	005997

NOTES:

SEAL XR FOLDING KNIFE

AVAILABLE JULY 2019

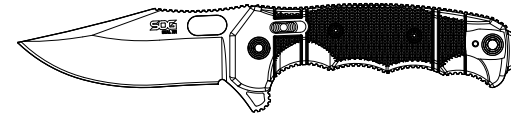

BLADE 3.90in / 99mm **LENGTH** 9.20in / 234mm
WEIGHT 8.20oz / 232g **HANDLE** GRN **STEEL** S35VN

AVAILABLE CONFIGURATIONS	PART #	DEALER
SEAL XR - Black TiNi	12-21-01-57	011330

NOTES:

TERMINUS XR FOLDING KNIFE

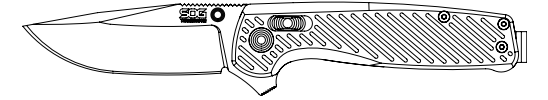

BLADE 2.95in / 75mm **LENGTH** 7.21in / 183mm
WEIGHT 3.20oz / 91g **HANDLE** G10 W/ CARBON FIBER **STEEL** CTS B0Z1

AVAILABLE CONFIGURATIONS	PART #	DEALER
Terminus XR - Satin	tttttt	004663

NOTES:

KIKU - ASSISTED ASSISTED FOLDING KNIFE

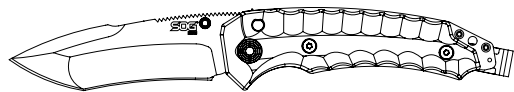

BLADE 3.50in / 89mm **LENGTH** 8.10in / 206mm
WEIGHT 5.60oz / 159g **HANDLE** LINEN MICARTA **STEEL** VG-10

AVAILABLE CONFIGURATIONS	PART #	DEALER
Kiku - Assisted - Black	KU-3002	009330
Kiku - Assisted - Satin	KU-3001	008663

NOTES:

TAC OPS AUTOMATIC



BLADE 3.50in / 89mm **LENGTH** 8.20in / 208mm
WEIGHT 4.60oz / 130g **HANDLE** LINEN MICARTA **STEEL** CPM S35VN

AVAILABLE CONFIGURATIONS	PART #	DEALER
Tac Ops Auto - Hard Cased Black	T01011-BX	013330

NOTES:

TERMIUS XR G10 FOLDING KNIFE

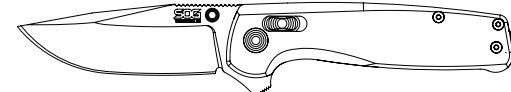

BLADE 2.95in / 75mm **LENGTH** 7.21in / 183mm
WEIGHT 3.20oz / 91g **HANDLE** G10 **STEEL** CTS B0Z1

AVAILABLE CONFIGURATIONS	PART #	DEALER
Terminus XR G10 - Olive Drab	TM1022-BX	003330
Terminus XR G10 - Crimson	TM1023-BX	003330

NOTES:

SPEC-ELITE I AUTOMATIC

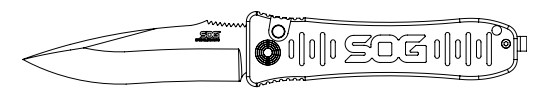

BLADE 3.50in / 89mm **LENGTH** 7.80in / 198mm
WEIGHT 3.80oz / 79g **HANDLE** 6061-T6 ALUMINIUM **STEEL** AUS-8

AVAILABLE CONFIGURATIONS	PART #	DEALER
Spec-Elite I Auto - Black TiNi	SE-52	008663
Spec-Elite I Auto - Satin	SE-51	007997

NOTES:

STRAT OPS AUTOMATIC

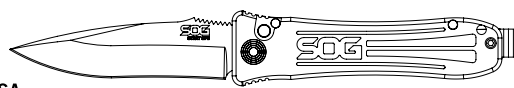

BLADE 3.50in / 89mm **LENGTH** 8.00in / 203mm
WEIGHT 3.70oz / 105g **HANDLE** LINEN MICARTA **STEEL** CPM S35VN

AVAILABLE CONFIGURATIONS	PART #	DEALER
Strat Ops Auto - Hard Cased Black	S01001-BX	012663

NOTES:

BANNER ASSISTED FOLDING KNIFE

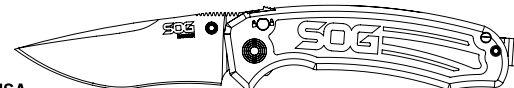

BLADE 3.50in / 89mm **LENGTH** 8.00in / 203mm
WEIGHT 4.60oz / 130g **HANDLE** 6061-T6 ALUMINIUM **STEEL** CPM S35VN

AVAILABLE CONFIGURATIONS	PART #	DEALER
Banner - Black TiNi	BA1001-BX	012663

NOTES:

SPEC-ELITE II AUTOMATIC

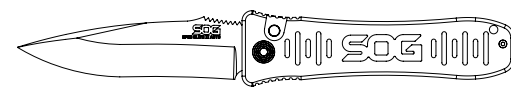

BLADE 4.00in / 102mm **LENGTH** 8.90in / 226mm
WEIGHT 3.60oz / 102g **HANDLE** 6061-T6 ALUMINIUM **STEEL** AUS-8

AVAILABLE CONFIGURATIONS	PART #	DEALER
Spec-Elite II Auto - Black TiNi	SE-62	009330
Spec-Elite II Auto - Satin	SE-61	008663

NOTES:

SOG-TAC AUTOMATIC

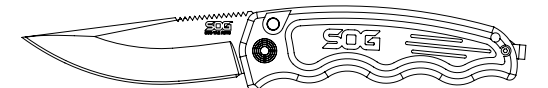

BLADE 3.50in / 89mm **LENGTH** 8.00in / 203mm
WEIGHT 3.80oz / 108g **HANDLE** 6061-T6 ALUMINIUM **STEEL** AUS-8

AVAILABLE CONFIGURATIONS	PART #	DEALER
SOG-TAC Automatic - Black TiNi	ST-02	008663
SOG-TAC Automatic - Partially Serrated, Tanto, Black TiNi	ST-04	008663
SOG-TAC Automatic - Tactical Drop Point, Black TiNi	ST-06	008663

NOTES:

SOG-TAC MINI AUTOMATIC



BLADE 3.00in / 76mm **LENGTH** 6.75in / 171mm
WEIGHT 2.50oz / 71g **HANDLE** 6061-T6 ALUMINIUM **STEEL** AUS-8

AVAILABLE CONFIGURATIONS	PART #	DEALER
SOG-TAC Mini Automatic - Black TiNi	ST-11	007997
SOG-TAC Mini Automatic - Partially Serrated, Tanto, Black TiNi	ST-13	007997

NOTES:

SOG-TAC CA SPECIAL AUTOMATIC

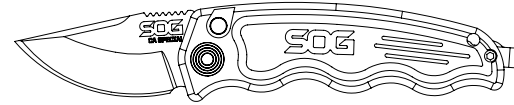

BLADE 2.00in / 48mm **LENGTH** 5.80in / 147mm
WEIGHT 2.30oz / 65g **HANDLE** 6061-T6 ALUMINIUM **STEEL** AUS-8

AVAILABLE CONFIGURATIONS	PART #	DEALER
SOG-TAC CA Special - Black TiNi	ST-14	006663

NOTES:

AEGIS ASSISTED FOLDING KNIFE



BLADE 3.50in / 89mm **LENGTH** 8.25in / 210mm
WEIGHT 3.10oz / 88g **HANDLE** GRN **STEEL** AUS-8

AVAILABLE CONFIGURATIONS	PART #	DEALER
Aegis Digi Camo - Black TiNi Tanto Partially Serrated	AE07-CP	006063
Aegis Digi Camo - Black TiNi	AE06-CP	006063
Aegis - Black TiNi Tanto Partially Serrated	AE04-CP	005530
Aegis - Black TiNi	AE02-CP	005530

NOTES:

TWITCH XL WOOD ASSISTED FOLDING KNIFE

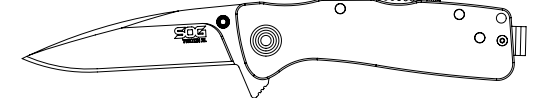

BLADE 3.25in / 83mm **LENGTH** 7.50in / 191mm
WEIGHT 4.20oz / 119g **HANDLE** WOOD **STEEL** AUS-8

AVAILABLE CONFIGURATIONS	PART #	DEALER
Twitch XL - Satin	TW124-CP	005797

NOTES:

ZOOM - CARBON FIBER ASSISTED FOLDING KNIFE

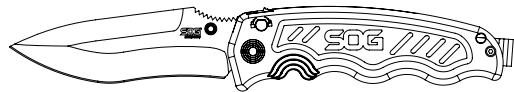

BLADE 3.60in / 91mm **LENGTH** 8.30in / 208mm
WEIGHT 4.50oz / 119g **HANDLE** 6061-T6 ALUMINIUM **STEEL** CPM S30V

AVAILABLE CONFIGURATIONS	PART #	DEALER
Zoom - Carbon Fiber Handle Satin	ZM1018-BX	011997

NOTES:

ZOOM ASSISTED FOLDING KNIFE



BLADE 3.60in / 91mm **LENGTH** 8.30in / 211mm
WEIGHT 4.50oz / 125g **HANDLE** 6061-T6 ALUMINIUM **STEEL** AUS-8

AVAILABLE CONFIGURATIONS	PART #	DEALER
Zoom - Partially Serrated, Black TiNi	ZM1016-BX	006530
Zoom - Black TiNi	ZM1012-BX	006530
Zoom - Satin	ZM1011-BX	006063

NOTES:

TWITCH II ASSISTED FOLDING KNIFE

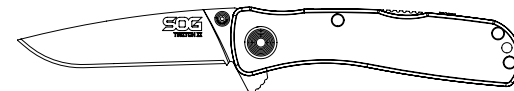

BLADE 2.65in / 68mm **LENGTH** 6.20in / 157mm
WEIGHT 2.60oz / 74g **HANDLE** VARIOUS **STEEL** AUS-8

AVAILABLE CONFIGURATIONS	PART #	DEALER
Twitch II - Wood Handle	TW117-CP	004130
Twitch II - Wood Handle	TW117-BX	004130
Twitch II - Black	TW112-CP	004130
Twitch II - Satin	TW18-CP	003530
Twitch II - Satin	TW18-BX	003530

NOTES:

FLASH II ASSISTED FOLDING KNIFE

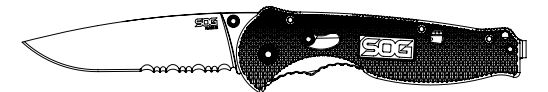

BLADE 3.5in / 89mm **LENGTH** 8.00in / 203mm
WEIGHT 3.10oz / 88g **HANDLE** GRN **STEEL** AUS-8

AVAILABLE CONFIGURATIONS	PART #	DEALER
Flash II - Partially Serrated Black TiNi	TFSA98-CP	004263
Flash II - Partially Serrated Black TiNi	TFSA98-BX	004263
Flash II - Tanto Black TiNi Partially Serrated	TFSAT98-CP	004263
Flash II - Tanto Black TiNi Straight	TFSAT8-CP	004263
Flash II - Tanto Black TiNi Straight	TFSAT8-BX	004263
Flash II - Partially Serrated Satin	FSA98-CP	003663
Flash II - Tanto Satin Partially Serrated	FSAT98-CP	003663
Flash II - Straight Edge Satin	FSA8-CP	003663
Flash II - Straight Edge Satin	FSA8-BX	003663
Flash II - Tanto Satin Straight Edge	FSAT8-CP	003663

NOTES:

TRIDENT ASSISTED FOLDING KNIFE



BLADE 3.75in / 95mm **LENGTH** 8.60in / 216mm
WEIGHT 3.60oz / 102g **HANDLE** GRN **STEEL** AUS-8

AVAILABLE CONFIGURATIONS	PART #	DEALER
Trident - Partially Serrated Copper TiNi Desert Camo	TF5-CP	005530
Trident - Partially Serrated Copper TiNi Desert Camo	TF5-BX	005530
Trident - Straight Tanto Black TiNi	TF7-CP	005530
Trident - Partially Serrated TigerStripe	TF3-CP	005530

NOTES:

TRIDENT ELITE ASSISTED FOLDING KNIFE



BLADE 3.70in / 94mm **LENGTH** 8.70in / 221mm
WEIGHT 3.90oz / 111g **HANDLE** GRN & RUBBER **STEEL** AUS-8

AVAILABLE CONFIGURATIONS	PART #	DEALER
Trident Elite - Partially Serrated Black TiNi	TF106-CP	005530
Trident Elite - Partially Serrated Black TiNi	TF106-BX	005530
Trident Elite - Straight Edge Tanto Black TiNi	TF104-CP	005530
Trident Elite - Satin	TF101-CP	004797
Trident Elite - Satin	TF101-BX	004797
Trident Elite - Straight Edge Tanto Satin	TF103-CP	004797
Trident Elite - Straight Edge Tanto Satin	TF103-BX	004797

NOTES:

SLIMJIM XL ASSISTED FOLDING KNIFE

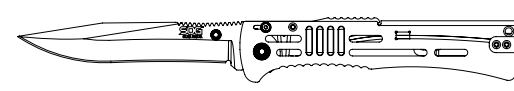

BLADE 4.18in / 106mm **LENGTH** 9.36in / 238mm
WEIGHT 2.70oz / 77g **HANDLE** STAINLESS STEEL **STEEL** AUS-8

AVAILABLE CONFIGURATIONS	PART #	DEALER
SlimJim XL - Black	SJ52-CP	004330
SlimJim XL - Satin	SJ51-CP	003863

NOTES:

SLIMJIM ASSISTED FOLDING KNIFE

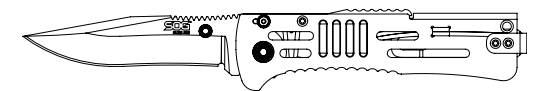

BLADE 3.18in / 81mm **LENGTH** 7.40in / 181mm
WEIGHT 2.40oz / 68g **HANDLE** STAINLESS STEEL **STEEL** AUS-8

AVAILABLE CONFIGURATIONS	PART #	DEALER
SlimJim - Black	SJ32-CP	003663
SlimJim - Satin	SJ31-CP	003130

NOTES:

TERMINUS FOLDING KNIFE

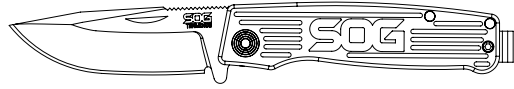

BLADE 3.00in / 76mm **LENGTH** 7.00in / 178mm
WEIGHT 2.90oz / 82g **HANDLE** G10 **STEEL** CTS BD1

AVAILABLE CONFIGURATIONS	PART #	DEALER
Terminus - Black	TM1002-BX	003997
Terminus - Satin	TM1001-BX	003330

NOTES:

KILOWATT FOLDING KNIFE



BLADE 3.40in / 86mm **LENGTH** 7.50in / 191mm
WEIGHT 3.30oz / 94g **HANDLE** GRN **STEEL** AUS-8

AVAILABLE CONFIGURATIONS	PART #	DEALER
Kilowatt - Satin	EL01-CP	003330

NOTES:

SALUTE FOLDING KNIFE

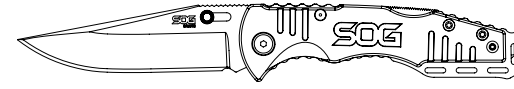

BLADE 3.63in / 92mm **LENGTH** 8.25in / 220mm
WEIGHT 4.20oz / 119g **HANDLE** G10 **STEEL** 8CR13MOV

AVAILABLE CONFIGURATIONS	PART #	DEALER
Salute - Black Oxide	FF11-CP	002330

NOTES:

SALUTE MINI FOLDING KNIFE

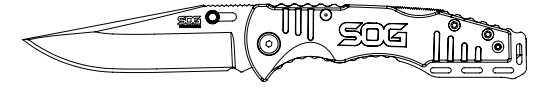

BLADE 3.10in / 79mm **LENGTH** 7.10in / 180mm
WEIGHT 3.60oz / 102g **HANDLE** G10 **STEEL** 8CR13MOV

AVAILABLE CONFIGURATIONS	PART #	DEALER
Salute Mini- Black Oxide G10	FF1101-CP	001997
Salute Mini- Bead Blast G10	FF1001-CP	001797

NOTES:

ESCAPE FOLDING KNIFE

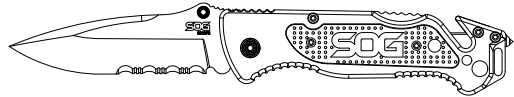

BLADE 3.40in / 86mm **LENGTH** 8.20in / 208mm
WEIGHT 4.80oz / 136g **HANDLE** ALUMINIUM **STEEL** 9CR18MOV

AVAILABLE CONFIGURATIONS	PART #	DEALER
Escape - Black	FF25-CP	002997
Escape - Bead Blasted	FF24-CP	002663

NOTES:

SIDESWIPE FOLDING KNIFE

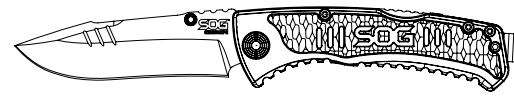

BLADE 3.40in / 86mm **LENGTH** 7.85in / 201mm
WEIGHT 3.50oz / 99g **HANDLE** ALUMINIUM **STEEL** 7CR15

AVAILABLE CONFIGURATIONS	PART #	DEALER
SideSwipe - Grey TINI	SW1011-CP	002663

NOTES:

AEGIS FLK FOLDING KNIFE

AVAILABLE JULY 2019

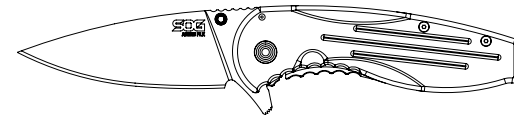

BLADE 3.38in / 86mm **LENGTH** 7.90in / 201mm
WEIGHT 5.10oz / 145g **HANDLE** STAINLESS STEEL **STEEL** 8CR13MOV

AVAILABLE CONFIGURATIONS	PART #	DEALER
Aegis FLK - Stone Washed	14-41-02-42	001997

NOTES:

ESCAPE FL FOLDING KNIFE

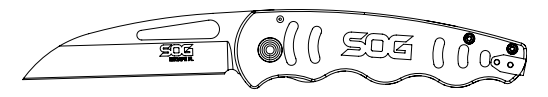

BLADE 3.50in / 89mm **LENGTH** 8.00in / 203mm
WEIGHT 3.20oz / 91g **HANDLE** STAINLESS STEEL **STEEL** 8CR13MOV

AVAILABLE CONFIGURATIONS	PART #	DEALER
Escape FL - Bead Blasted	14-52-01-41	001330

NOTES:

CASHCARD FOLDING KNIFE

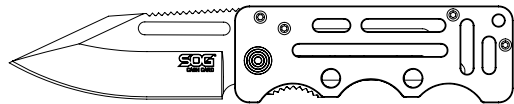

BLADE 2.75in / 70mm **LENGTH** 6.20in / 155mm
WEIGHT 2.00oz / 57g **HANDLE** STAINLESS STEEL **STEEL** 8CR13MOV

AVAILABLE CONFIGURATIONS	PART #	DEALER
CashCard - Satin	EZ1-CP	001997

NOTES:

FLARE FOLDING KNIFE

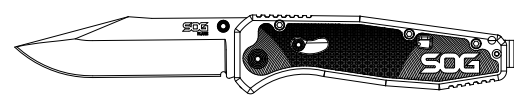

BLADE 3.50in / 89mm **LENGTH** 8.10in / 206mm
WEIGHT 3.10oz / 88g **HANDLE** GRN **STEEL** 8CR13MOV

AVAILABLE CONFIGURATIONS	PART #	DEALER
Flare - Satin	FLA1001-CP	001997

NOTES:

FLASH FL FOLDING KNIFE

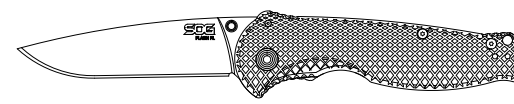

BLADE 3.44in / 87mm **LENGTH** 7.97in / 202mm
WEIGHT 5.25oz / 149g **HANDLE** STAINLESS STEEL **STEEL** 8CR13MOV

AVAILABLE CONFIGURATIONS	PART #	DEALER
Flash FL - Stone Washed	14-18-01-41	001330

NOTES:

FIELDER G10 FOLDING KNIFE

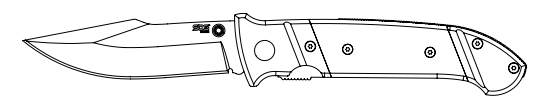

BLADE 3.30in / 84mm **LENGTH** 7.80in / 198mm
WEIGHT 4.40oz / 125g **HANDLE** G10 **STEEL** 7CR17

AVAILABLE CONFIGURATIONS	PART #	DEALER
Fielder - Satin	FF38-CP	001663

NOTES:

FIELDER WOOD FOLDING KNIFE

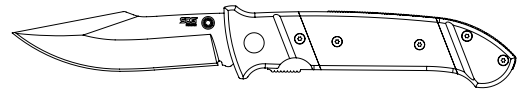

BLADE 3.30in / 84mm **LENGTH** 7.80in / 198mm
WEIGHT 4.40oz / 125g **HANDLE** WOOD **STEEL** 7CR17

AVAILABLE CONFIGURATIONS	PART #	DEALER
Fielder - Satin	FF30-CP	001330

NOTES:

TRACTION FOLDING KNIFE

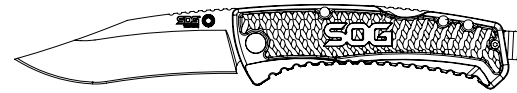

BLADE 3.50in / 89mm **LENGTH** 8.00in / 203mm
WEIGHT 2.40oz / 68g **HANDLE** GRN **STEEL** 5CR13MOV

AVAILABLE CONFIGURATIONS	PART #	DEALER
Traction - Satin Tanto	TD1012-CP	001663
Traction - Satin	TD1011-CP	001663

NOTES:





KEYCHAIN TOOLS

We get it, you can't take a 7 inch Bowie Knife or an automatic opener everywhere. But you know how to make the most of even the smallest tools. That's what keychain tools are all about. Small, under the radar, but reliable. Whether it's a knife for your keychain or a multi-tool in your coin pocket, keychain tools are designed to give you as much capability in as little a package as possible.

KEYTRON FOLDING KNIFE

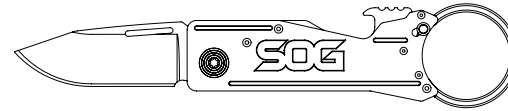

BLADE 1.80in / 47mm **LENGTH** 5.40in / 136mm
WEIGHT 1.30oz / 37g **HANDLE** STAINLESS STEEL **STEEL** 5CR13MOV

AVAILABLE CONFIGURATIONS	PART #	DEALER
Keytron - Satin	KT1001-CP	001330

NOTES:

CENTI I FOLDING KNIFE

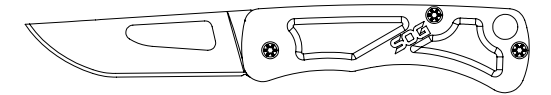

BLADE 1.40in / 36mm **LENGTH** 3.40in 86mm
WEIGHT 0.40oz / 11g **HANDLE** STAINLESS STEEL **STEEL** 3CR13

AVAILABLE CONFIGURATIONS	PART #	DEALER
Centi I - Satin	CE1002-CP	000663

NOTES:

CENTI II FOLDING KNIFE

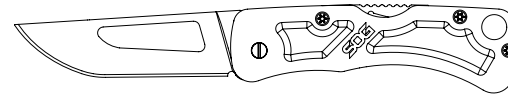

BLADE 2.10in / 53mm **LENGTH** 5.00in / 127mm
WEIGHT 1.30oz / 37g **HANDLE** STAINLESS STEEL **STEEL** 3CR13

AVAILABLE CONFIGURATIONS	PART #	DEALER
Centi II - Satin	CE1012-CP	000663

NOTES:

KEY KNIFE FOLDING KNIFE

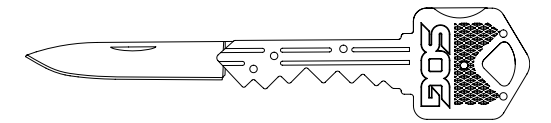

BLADE 1.50in / 38mm **LENGTH** 4.00in / 102mm
WEIGHT 0.70oz / 20g **HANDLE** STAINLESS STEEL **STEEL** 5CR13MOV

AVAILABLE CONFIGURATIONS	PART #	DEALER
Key Knife - Black	KEY-101	000730
Key Knife - Brass	KEY102-CP	000730

NOTES:

BITE BOTTLE OPENER

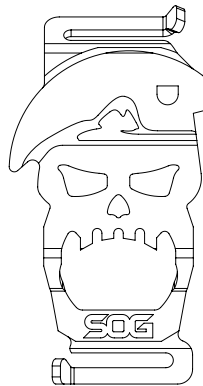

LENGTH 2.50in / 64mm **WEIGHT** 0.60oz / 28g
STEEL 3CR13

AVAILABLE CONFIGURATIONS	PART #	DEALER
Bite - Black	BT1001-CP	000663

NOTES:

MACV MULTI-TOOL

12
TOOLS

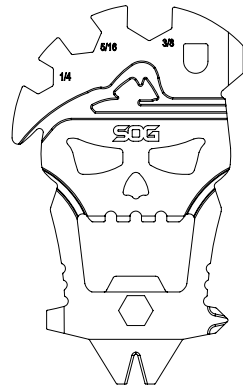

LENGTH 2.50in / 64mm **WEIGHT** 0.60oz / 17g
STEEL 3CR13 **COMPONENTS** 12

AVAILABLE CONFIGURATIONS	PART #	DEALER
MacV Tool - Hard Cased Black	SM1001-CP	000663

NOTES:

FLINT MULTI-TOOL

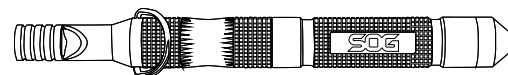

LENGTH 4.30in / 109mm **WEIGHT** 0.70oz / 20g
MATERIAL ALUMINUM **COMPONENTS** 5

AVAILABLE CONFIGURATIONS	PART #	DEALER
Flint - Black Hard Anodized	FT1001-CP	000997

NOTES:

FIXED BLADES

Our heritage begins with the fixed blade, the classic SOG Bowie Knife inspired by the Special Forces of Vietnam. In the 32 years since then, we've continued to make fixed blades for professionals both in and outside the military. We make our knives to be reliable and durable, and covered by a lifetime warranty. Heck, send them to us if you just want them sharpened. No matter who you are, whether you're the adventure-seeking outdoorsman, or the seasoned first responder, SOG has a fixed blade for you.

SUPER SOG BOWIE FIXED BLADE

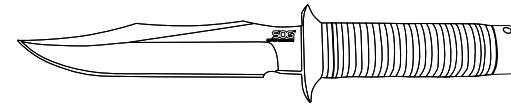

BLADE 7.50in / 191mm **LENGTH** 12.88in / 327mm **WEIGHT** 17.40oz / 493g
HANDLE LEATHER WASHERS AND STAINLESS STEEL **STEEL** AUS-8

AVAILABLE CONFIGURATIONS	PART #	DEALER
Super SOG Bowie - Hardcased Black TiNi Leather Sheath	SB1T-L	015063

NOTES:

PILLAR FIXED BLADE

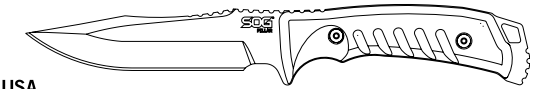

USA
MADE

BLADE 5.00in / 127mm **LENGTH** 9.90in / 251mm **WEIGHT** 7.30oz / 207g
HANDLE LINEN MICARTA **STEEL** CPM S35V

AVAILABLE CONFIGURATIONS	PART #	DEALER
Pillar - Stone Washed Kydex Sheath	UF1001-BX	012663

NOTES:

BOWIE 2.0 FIXED BLADE

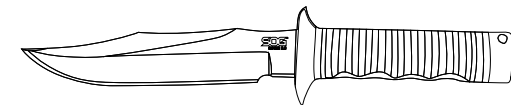

BLADE 6.40in / 163mm **LENGTH** 11.00in / 279mm **WEIGHT** 11.20oz / 318g
HANDLE LEATHER WASHERS AND STAINLESS STEEL **STEEL** AUS-8

AVAILABLE CONFIGURATIONS	PART #	DEALER
Bowie 2.0 - Hardcased Black TiNi Leather Sheath	ST-L	012063

NOTES:

TECH BOWIE FIXED BLADE

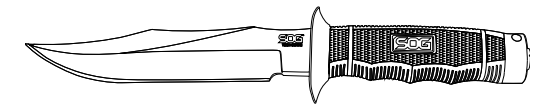

BLADE 6.40in / 163mm **LENGTH** 11.00in / 279mm **WEIGHT** 11.20oz / 318g
HANDLE RUBBER AND STAINLESS STEEL **STEEL** AUS-8

AVAILABLE CONFIGURATIONS	PART #	DEALER
Tech Bowie - Hardcased Black TiNi Kydex Sheath	S10B-K	010063

NOTES:

KIKU 4" FIXED BLADE



BLADE 4.10in / 104mm **LENGTH** 8.60in / 218mm **WEIGHT** 7.40oz / 210g
HANDLE LINEN MICARTA **STEEL** VG-10

AVAILABLE CONFIGURATIONS	PART #	DEALER
Kiku - 4in Fixed - Stone Washed Kydex Sheath	KU-2021	012663

NOTES:

SEAL TEAM ELITE FIXED BLADE

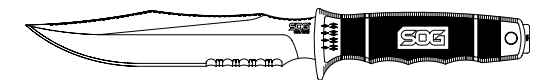

BLADE 7.00in / 178mm **LENGTH** 12.30in / 312mm **WEIGHT** 10.30oz / 292g
HANDLE GRN **STEEL** AUS-8

AVAILABLE CONFIGURATIONS	PART #	DEALER
SEAL Team Elite - Black TiNi Nylon Sheath	SE37-N	009063
SEAL Team - Black TiNi Kydex Sheath	S37-K	008263

NOTES:

SEAL STRIKE FIXED BLADE

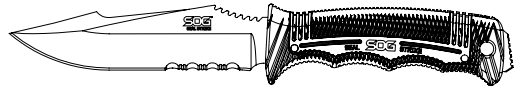

BLADE 4.90in / 125mm **LENGTH** 9.60in / 244mm **WEIGHT** 5.60oz / 159g
HANDLE GRN AND STAINLESS STEEL **STEEL** AUS-8

AVAILABLE CONFIGURATIONS	PART #	DEALER
SEAL Strike - Black TiNi Deluxe Sheath	SS1003-CP	006663
SEAL Strike - Powder Coat Molded Sheath	SS1001-CP	004330

NOTES:

SEAL PUP ELITE FIXED BLADE

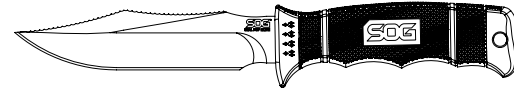

BLADE 4.85in / 123mm **LENGTH** 9.50in / 241mm **WEIGHT** 5.40oz / 153g
HANDLE GRN **STEEL** AUS-8

AVAILABLE CONFIGURATIONS	PART #	DEALER
SEAL Pup Elite - Black TiNi Partially Serrated Kydex Sheath	E37T-K	006530
SEAL Pup Elite - Black TiNi Partially Serrated Nylon Sheath	E37TN-CP	006063
SEAL Pup Elite - Black TiNi Straight Edge Nylon Sheath	E37SN-CP	006063
SEAL Pup Elite - Satin Straight Edge Nylon Sheath	E37N-CP	005330

NOTES:

INSTINCT FIXED BLADE

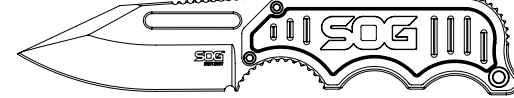

BLADE 2.30in / 58mm **LENGTH** 5.90in / 150mm **WEIGHT** 2.30oz / 65g
HANDLE G10 AND STAINLESS STEEL **STEEL** 5CR15MOV

AVAILABLE CONFIGURATIONS	PART #	DEALER
Instinct - Satin Molded Nylon Sheath	NB1012-CP	002330

NOTES:

INSTINCT MINI FIXED BLADE

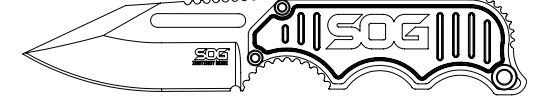

BLADE 1.90in / 48mm **LENGTH** 4.80in / 122mm **WEIGHT** 1.60oz / 45g
HANDLE G10 AND STAINLESS STEEL **STEEL** 5CR15MOV

AVAILABLE CONFIGURATIONS	PART #	DEALER
Instinct Mini - Satin Molded Nylon Sheath	NB1002-CP	001997

NOTES:

SEAL PUP FIXED BLADE



BLADE 4.75in / 121mm **LENGTH** 9.00in / 229mm **WEIGHT** 5.40oz / 153g
HANDLE GRN **STEEL** AUS-8

AVAILABLE CONFIGURATIONS	PART #	DEALER
SEAL Pup - Powder Coated Kydex Sheath	M37K	003997
SEAL Pup - Powder Coated Kydex Sheath	M37N-CP	003330

NOTES:

PENTAGON FIXED BLADE

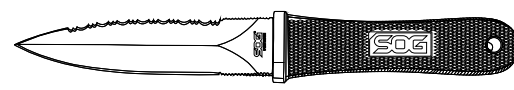

BLADE 5.00in / 127mm **LENGTH** 9.75in / 248mm **WEIGHT** 5.60oz / 159g
HANDLE RUBBER AND STAINLESS STEEL **STEEL** AUS-8

AVAILABLE CONFIGURATIONS	PART #	DEALER
Pentagon - Satin Nylon Sheath	S14-N	004663

NOTES:

GAMBIT FIXED BLADE



BLADE 2.58in / 66mm **LENGTH** 7.28in / 185mm **WEIGHT** 2.80oz / 79g
HANDLE GRN **STEEL** 7CR17MOV

AVAILABLE CONFIGURATIONS	PART #	DEALER
Gambit - Satin Molded Nylon Sheath	GB1001-CP	001663

NOTES:

JUNGLE PRIMITIVE FIXED BLADE

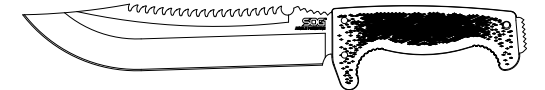

BLADE 9.50in / 241mm **LENGTH** 15.30in / 389mm **WEIGHT** 14.00oz / 397g
HANDLE RUBBER **STEEL** 8CR13MOV

AVAILABLE CONFIGURATIONS	PART #	DEALER
Jungle Primitive - Hardcased Black Nylon Sheath	F03TN-CP	003263

NOTES:

MINI PENTAGON FIXED BLADE

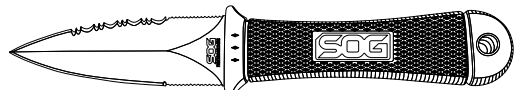

BLADE 3.63in / 92mm **LENGTH** 7.88in / 200mm **WEIGHT** 3.30oz / 94g
HANDLE RUBBER **STEEL** AUS-8

AVAILABLE CONFIGURATIONS	PART #	DEALER
Mini Pentagon - Satin Nylon Sheath	M14K-CP	003330

NOTES:

SNARL FIXED BLADE



BLADE 2.30in / 58mm **LENGTH** 4.30in / 109mm **WEIGHT** 1.90oz / 54g
HANDLE STAINLESS STEEL **STEEL** 9CR18MOV

AVAILABLE CONFIGURATIONS	PART #	DEALER
Snarl - Satin Molded Nylon Sheath	JB01K-CP	002663

NOTES:

FIELD KNIFE FIXED BLADE

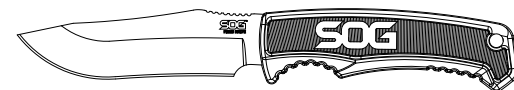

BLADE 4.00in / 102mm **LENGTH** 8.50in / 216mm **WEIGHT** 3.80oz / 108g
HANDLE RUBBER **STEEL** 7CR17MOV

AVAILABLE CONFIGURATIONS	PART #	DEALER
Field Knife - Satin GRN Sheath	FK1001-CP	001997

NOTES:

ACE FIXED BLADE

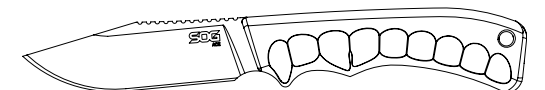

BLADE 3.80in / 97mm **LENGTH** 8.30in / 219mm **WEIGHT** 4.00oz / 113g
HANDLE RUBBER **STEEL** 7CR17MOV

AVAILABLE CONFIGURATIONS	PART #	DEALER
ACE - Stone Washed GRN Sheath	ACE1001-CP	001663

NOTES:



GEAR

Not every problem can be solved with a small hand-held tool, that's why SOG also makes a variety of lightweight and highly functional tools, including axes, saws with swappable blades, machetes for every path clearing occasion and the humble, yet essential, Entrenching Tool.

We even make some gear just for the fun of it, with our Throwing Hawks and Knives, so after you've dug your trench latrine, chopped some kindling, and cut a path, you can hone your skills on hitting the bullseye.

VOODOO HAWK MINI GEAR

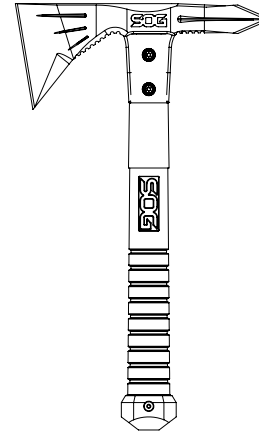

BLADE 2.75in / 70mm **LENGTH** 12.50in / 318mm **WEIGHT** 23.10oz / 655g
HANDLE GRN **STEEL** 3CR13MOV

AVAILABLE CONFIGURATIONS	PART #	DEALER
Voodoo Hawk Mini - Black Oxide Nylon Sheath	F183N-CP	003330
Voodoo Hawk Mini - Satin Nylon Sheath	F182N-CP	003330

NOTES:

SURVIVAL HAWK GEAR

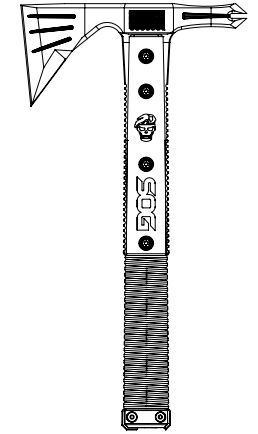

BLADE 2.75in / 70mm **LENGTH** 12.10in / 30.7 **WEIGHT** 19.50oz / 553g
HANDLE GRN **STEEL** 3CR13MOV

AVAILABLE CONFIGURATIONS	PART #	DEALER
Survival Hawk - Black Oxide Nylon Sheath	SK1001-CP	003663

NOTES:

TACTICAL TOMAHAWK GEAR

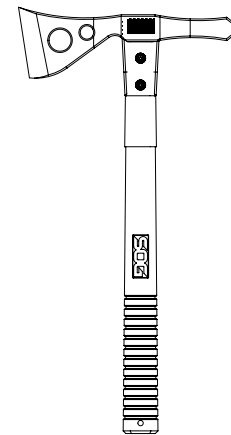

BLADE 2.75in / 70mm **LENGTH** 15.75in / 400mm **WEIGHT** 24.00oz / 680g
HANDLE GRN **STEEL** 420 STAINLESS

AVAILABLE CONFIGURATIONS	PART #	DEALER
Tactical Tomahawk - Polished Nylon Sheath	F01TN-CP	003330

NOTES:

SHEATH FOR TOMAHAWK GEAR

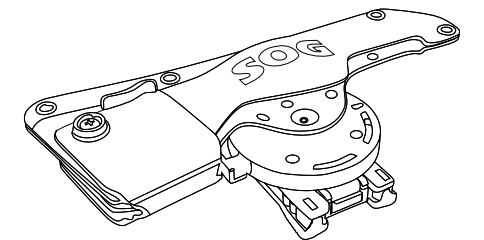

MATERIAL NYLON **WEIGHT** 7.10oz / 201g

AVAILABLE CONFIGURATIONS	PART #	DEALER
Molded Hard Nylon Sheath for Tactical Tomahawk	HDN-F01	001930

NOTES:

FASTHAWK GEAR

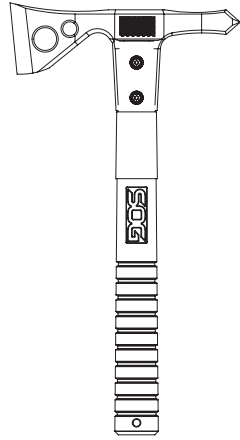

BLADE 2.00in / 51mm **LENGTH** 12.50in / 318mm **WEIGHT** 19.00oz / 539g
HANDLE GRN **STEEL** 420 STAINLESS

AVAILABLE CONFIGURATIONS	PART #	DEALER
FastHawk - Hardcased Black Nylon Sheath	F06TN-CP	002663
FastHawk - Polished Nylon Sheath	F06PN-CP	002663

NOTES:

SHEATH FOR FASTHAWK GEAR

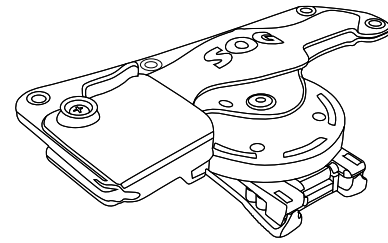

MATERIAL NYLON **WEIGHT** 6.10oz / 173g

AVAILABLE CONFIGURATIONS	PART #	DEALER
Molded Hard Nylon Sheath for FastHawk	HDN-F06	001663

NOTES:

THROWING KNIVES GEAR

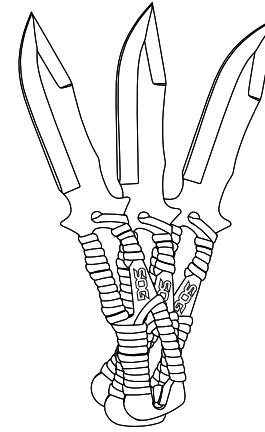

BLADE 4.40in / 112mm **LENGTH** 10.00in / 254mm **WEIGHT** 19.60oz / 142g
HANDLE 420 STAINLESS W/ PARACORD **STEEL** 420 STAINLESS

AVAILABLE CONFIGURATIONS	PART #	DEALER
Throwing Knives 3 Pack - Hardcased Black Nylon Sheath	F041TN-CP	002797

NOTES:

FLING GEAR

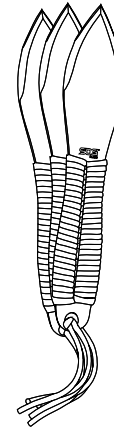

BLADE 2.80in / 71mm **LENGTH** 9.50in / 241mm **WEIGHT** 29.44oz / 153g
HANDLE 3CR13MOV W/ PARACORD **STEEL** 3CR13MOV

AVAILABLE CONFIGURATIONS	PART #	DEALER
Fling 3 Pack - Polished Nylon Sheath	FX41N-CP	002463

NOTES:

CAMP AXE GEAR

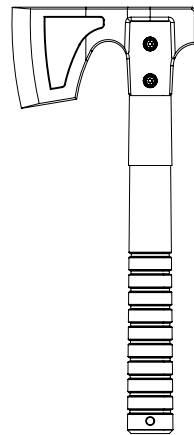

BLADE 2.75in / 70mm **LENGTH** 11.50in / 292mm **WEIGHT** 16.10oz / 456g
HANDLE GRN **STEEL** 2CR13

AVAILABLE CONFIGURATIONS	PART #	DEALER
Camp Axe - Polished Nylon Sheath	CH1001-CP	002997

NOTES:

THROWING HAWKS GEAR

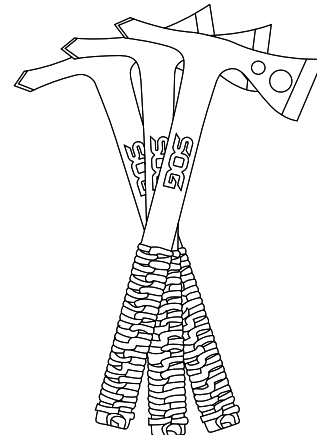

BLADE 1.75in / 45mm **LENGTH** 10.75in / 273mm **WEIGHT** 25.40oz / 224g
HANDLE STAINLESS STEEL W/ PARACORD **STEEL** 3CR13

AVAILABLE CONFIGURATIONS	PART #	DEALER
Throwing Hawks 3 Pack - Hardcased Black Nylon Sheath	TH1001-CP	003663

NOTES:

ELITE ENTRENCHING TOOL GEAR

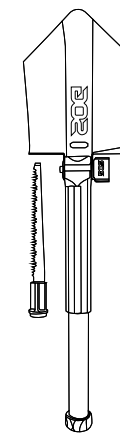

LENGTH 26.00in / 660mm **WEIGHT** 24.80oz / 703g
HANDLE GRN **MATERIAL** 1075 CARBON

AVAILABLE CONFIGURATIONS	PART #	DEALER
Elite Entrenching Tool - Hardcased Black Nylon Sheath Saw	F19-N	004063

NOTES:

ENTRENCHING TOOL GEAR

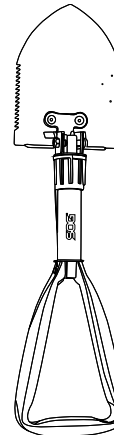

LENGTH 18.25in / 464mm **WEIGHT** 24.50oz / 695g
HANDLE HIGH CARBON STEEL **MATERIAL** HIGH CARBON

AVAILABLE CONFIGURATIONS	PART #	DEALER
Entrenching Tool - Hardcased Black Nylon Sheath	F08-N	001330

NOTES:

SOGFARI KUKRI MACHETE GEAR

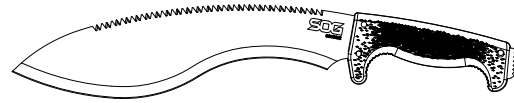

BLADE 2.80in / 305mm **LENGTH** 9.50in / 457mm **WEIGHT** 29.44oz / 425g
HANDLE 3CR13MOV W/ PARACORD **STEEL** 3CR13MOV

AVAILABLE CONFIGURATIONS	PART #	DEALER
SOGfari Kukri Machete	MC11-N	001997

NOTES:

SOGFARI - 10IN TANTO MACHETE GEAR

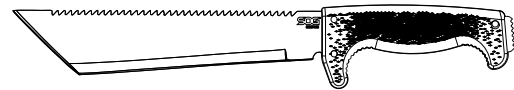

BLADE 10.00in / 254mm **LENGTH** 16.00in / 406mm **WEIGHT** 13.50oz / 383g
HANDLE RUBBER **STEEL** 3CR13

AVAILABLE CONFIGURATIONS	PART #	DEALER
SOGfari - 10in Tanto Machete	MC04-N	001663

NOTES:

FOLDING SAW GEAR

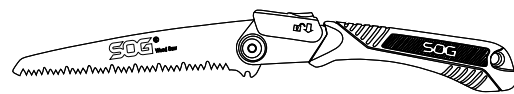

BLADE 9.25in / 210mm **LENGTH** 17.25in / 438mm **WEIGHT** 9.20oz / 261g
HANDLE HIGH CARBON STEEL AND TPR **STEEL** HIGH CARBON STEEL

AVAILABLE CONFIGURATIONS	PART #	DEALER
Folding Saw	F10N-CP	001263

NOTES:

SOGFARI - 18IN MACHETE GEAR

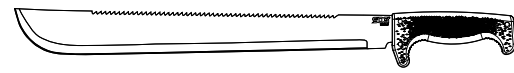

BLADE 18.00in / 457mm **LENGTH** 24.00in / 610mm **WEIGHT** 15.70oz / 522g
HANDLE RUBBER **STEEL** 3CR13

AVAILABLE CONFIGURATIONS	PART #	DEALER
SOGfari - 18in Machete	MC02-N	001997

NOTES:

SOGFARI - 13IN MACHETE GEAR

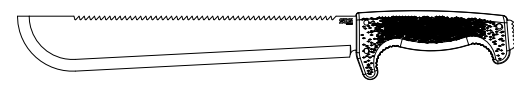

BLADE 13.00in / 330mm **LENGTH** 19.00in / 483mm **WEIGHT** 13.00oz / 371g
HANDLE RUBBER **STEEL** 3CR13

AVAILABLE CONFIGURATIONS	PART #	DEALER
SOGfari - 13in Machete	MC01-N	001663

NOTES:

COUNTERTOP SHARPENER

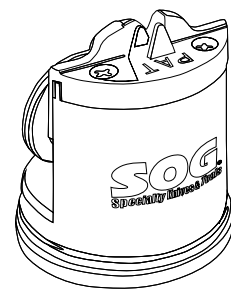

HEIGHT 2.50in / 70mm **WEIGHT** 3.00oz / 85g

AVAILABLE CONFIGURATIONS	PART #	DEALER
Countertop Sharpener	SH-02	001263

NOTES:





PACKS

Built from durable 500D Nylon and Hypalon®, SOG Packs are water resistant, durable, and yet still lightweight enough to be taken virtually anywhere. With options for long-carry items and a unique hard-molded upper pocket for enhanced protection of sensitive items, SOG packs deliver versatile carry solutions. Whether it's for your daily commute, backpacking adventure, or overseas travel, each pack features a considered interior organization system.

SERAPHIM 35 PACK

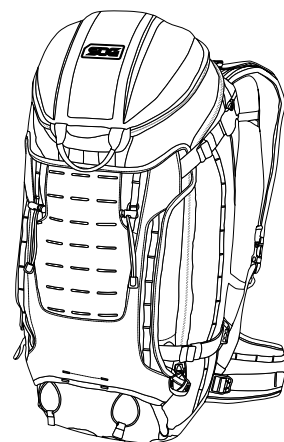

VOLUME 35L **HEIGHT** 26.40in / 670mm **WEIGHT** 58.60 oz / 1.66kg
MATERIALS 500D N/P HYBRID HEATHERED FABRIC

AVAILABLE CONFIGURATIONS	PART #	DEALER
Seraphim 35 - Black	CP1006B	013330
Seraphim 35 - Grey	CP1006G	013330

NOTES:

BLADE 2.30in / 58mm **LENGTH** 5.90in / 150mm **WEIGHT** 2.30oz / 65g
HANDLE G10 AND STAINLESS STEEL **STEEL** 5CR15MOV

PROPHET 33 PACK

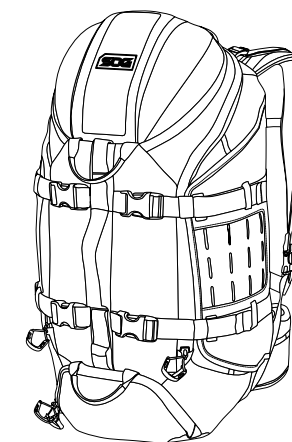

VOLUME 33L **HEIGHT** 24.00in / 610mm **WEIGHT** 58.40 OZ / 1.65kg
MATERIALS 500D N/P HYBRID HEATHERED FABRIC

AVAILABLE CONFIGURATIONS	PART #	DEALER
Prophet 33 - Black	CP1005B	011997
Prophet 33 - Grey	CP1005G	011997

NOTES:

SCOUT 24 PACK

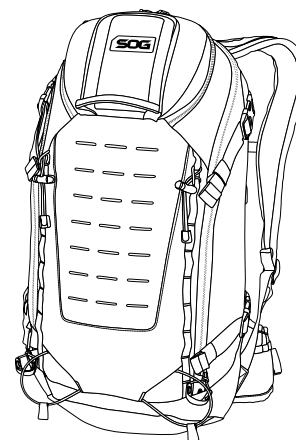

VOLUME 24L **HEIGHT** 21.30in / 541mm **WEIGHT** 44.50 OZ / 1.26kg
MATERIALS 500D N/P HYBRID HEATHERED FABRIC

AVAILABLE CONFIGURATIONS	PART #	DEALER
Scout 24 - Black	CP1004B	009997
Scout 24 - Grey	CP1004G	009997

NOTES:

TOC 20 PACK



VOLUME 20L **HEIGHT** 20.10in **WEIGHT** 32.50 OZ / 0.92kg
MATERIALS 500D N/P HYBRID HEATHERED FABRIC

AVAILABLE CONFIGURATIONS	PART #	DEALER
TOC 20 - Black	CP1003B	007997
TOC 20 - Grey	CP1003G	007997

NOTES:

GENERAL TERMS AND CONDITIONS FOR SOG WHOLESALE ACCOUNT

Sales Policy

All SOG® and Tool Logic® products purchased at wholesale pricing must be sold under the terms and conditions set forth below. Publication and distribution of SOG and Tool Logic catalogs and/or price lists do not constitute an offer to sell.

Prices

Prices are subject to change without notice. All orders received by SOG will be deemed to be submitted at “prices in effect” upon receipt of order.

Qualifications

1. Customers are required to have a storefront, mail order catalog, or online presence.
2. Customers must provide completed and signed dealer application, copy of business license, and state tax ID#.
3. A minimum opening order of \$500 must be submitted with dealer application.
4. Customers must meet price level qualifications to maintain given price level.

Terms

Decisions concerning the extension of credit terms are made by SOG at its sole discretion. We will require a copy of your business license state tax ID# and a completed application for approval (this includes credit card accounts). Accounts that satisfy SOG’s credit criteria may purchase products from SOG on a 2% 10/net 30 day basis from invoice date. Shipments refused for any reason will be assessed a charge equal to the return shipment fee. Returned checks are subject to a \$25 surcharge. Past due balances are subject to a service charge of 2% per month.

Freight

All orders will ship Wisconsin via UPS insured ground service unless otherwise specified. SOG reserves the right to choose the most economical carrier on larger shipments. The purchaser shall assume the risk of loss for all freight collect shipments (or shipments where you secure your own insurance policy) upon leaving our facility. Prepaid freight is available for certain price levels and minimum orders – consult your pricing level outline for details.

Shortages

Claims against the seller for shortages must be communicated directly to SOG within 5 days of the arrival of the shipment.

Back Orders

Items not in stock at time of order will be placed on back order. Back orders will remain open until shipped or cancelled.

Reselling

Accounts buying on the Wholesale, Direct 6, or Direct 10 may only sell SOG Products to end consumers and shall not engage in selling SOG Products to other retailers or wholesalers authorized or not. SOG distributors must have an in-force SOG Distribution Agreement in order to re-sell at wholesale.

General Warranty

All SOG and Tool Logic products carry a lifetime guarantee against defects in workmanship and materials. This guarantee is voided by misuse, abuse, improper maintenance, or alterations of the product and does not cover any normal wear that might occur. All warranty claims should be directed to SOG. Only SOG is authorized to replace or repair a defective product. SOG must first examine the product to determine whether to repair or replace it. Retailers are not authorized to exchange product and must contact SOG for warranty authorization or send the customer directly to SOG for resolution. U.S. claims should be sent prepaid and insured. SOG reserves the right to repair or replace product at our discretion. For more information on SOG warranty see: <http://www.sogknives.com/warranty-info.html>.

Return Goods Policy

A valid SOG return authorization number must be obtained prior to returning goods. All returned or refused goods are subject to a 15% restocking fee. Freight on all returns must be prepaid; products must be inline, include original packaging, free of stickers or labels, and not damaged. SOG will issue a credit memo – for net costs of goods less restocking fee – to be applied to future purchases only.

Automatic Knives

SOG automatic knives will only be shipped to dealers or other legal entities that sign and return the Automatic Release Form stating that they are in compliance with the required Federal statutes.

ONLINE 3P POLICY AMENDMENT Effective August 1, 2018

SOG manages its products distribution in 3P marketplace channels via the following policy:

SOG will not allow any unauthorized entity to sell our products on the Amazon, Walmart.com and Jet.com 3P platforms.

Authorization is conferred via written permission from the SOG VP of Sales and must be renewed annually.

We will take the following actions when discovering unauthorized sellers:

- First violation: written warning
- Second violation: 60 days on SOGs DNS (Do Not Sell) list
- Third violation: permanently placed on DNS list

MINIMUM ADVERTISED PRICE (“MAP”) POLICY Effective April 1, 2014

In order to enhance and preserve its reputation for providing customers with high value products and to further enhance the SOG® brand image and its competitiveness in the marketplace, SOG Specialty Knives and Tools, LLC (“SOG”) is unilaterally instituting a policy of minimum advertised price standards for SOG brand products. This Minimum Advertised Pricing Policy (“MAP Policy”) shall be effective April 1, 2014 and shall remain in effect until amended or withdrawn by SOG in writing. This policy supersedes and replaces all prior MAP pricing policies applicable to SOG products. It applies to all dealers, distributors, retailers, and other resellers, including catalog and internet resellers (collectively, “Resellers”), who resell SOG products to end users located in the United States.

SOG greatly values the efforts of all Resellers to distribute SOG products in support of our customers and consumers. This MAP Policy is adopted for the benefit of all Resellers and will be uniformly enforced. This MAP Policy shall work under the following guidelines:

1. Each Reseller selling SOG products remains free to establish its own resale prices and promotions; however, SOG may, without assuming any liability, refuse to sell, either directly or through distribution, to any Reseller following verification by SOG to its sole satisfaction that the Reseller has violated this MAP Policy.
2. Each Reseller of SOG products is free to independently decide whether or not to follow this Policy. SOG does not ask for nor will it accept any assurance of compliance or agreement from a Reseller regarding this Policy, nor will SOG discuss any conditions of acceptance related to this Policy. Notwithstanding anything to the contrary which may be expressed or implied in or by one or more agreements between the Reseller and SOG (including without limitation any Reseller agreement), nothing in those agreements shall constitute an agreement by the Reseller to comply with this Policy.
3. This MAP policy does not establish maximum advertised prices. All resellers may offer SOG products at any price in excess of the MAP established for such products.
4. SOG will, from time to time, publish Minimum Advertised Price Schedule (“MAP Schedule”) for some or all of its products as part, or in concert with, the publication of updated price lists, catalogs, or other selling materials which may be distributed in physical form, electronically, or on its website. MAP Schedules will identify the products, effective date, and specific MAP Prices for products covered under this MAP Policy. Each advertisement of a product identified in the MAP Schedule at a price below the specified MAP Price listed will be a violation of this MAP Policy. Products without MAP Prices specified in the MAP Schedule are not subject to this MAP Policy. The initial MAP Schedule is distributed along with this document.
5. This MAP Policy applies to all advertisements of SOG products listed on the MAP Schedule in any and all media, including, but not limited to, flyers, posters, coupons, mailers, inserts, newspapers, magazines, catalogs, mail order catalogs, e-mail newsletters, e-mail solicitations, internet or similar electronic media, television, radio, and public signage. This MAP Policy is not applicable to any in-store advertising that is displayed only in the store and not distributed to any customer(s).
6. The inclusion in advertising of free or discounted products (whether made by SOG or another manufacturer) with a product covered by this MAP Policy would be contrary to this MAP Policy if it has the effect of discounting the advertised price of the covered SOG product more below the specified MAP Price.
7. If advertised pricing is displayed, any alteration, strike-through or discount which is paired with an allowable price that results in a discounted advertised price below the MAP Price is prohibited.
8. This MAP Policy applies only to advertised prices and does not apply to the price at which SOG products are actually sold or offered for sale to an individual consumer within Resellers’ retail location or over the telephone. Resellers may sell these products at any prices they choose under these circumstances without violating this MAP Policy.
9. Internet auctions may not display or have reserved bid or other acceptable prices below the MAP Price.
10. Pricing listed on an internet site is considered an “advertised price” and must adhere to this MAP Policy. Once the pricing is associated with an intent to purchase (added to shopping cart or order), the price becomes the selling price and is not bound by this MAP Policy. Statements such as “add to basket to see price”, “we will match any price”, “call for price” or phrases of similar import are acceptable as long as the price advertised or listed for the products is not below the MAP Price. In addition, discounts applied at checkout to the entire order based on a customer’s purchasing history with the Reseller, such as discounts for “frequent shoppers”, do not violate this MAP Policy.
11. From time to time, SOG may choose to offer special promotions on certain products. In such an event, SOG reserves the right to modify or suspend this MAP Policy in whole or in part by notifying all Resellers of the duration and nature of the change. SOG further reserves the right to adjust the MAP Prices with respect to all or certain products at its sole discretion. Such changes shall apply equally to all Resellers.
12. Intentional failure to abide by this MAP Policy will result in sanctions unilaterally imposed by SOG. The level of sanctions will be determined by SOG in its sole discretion. SOG does not intend to do business with Resellers who degrade the image of SOG and its products. SOG may choose to, but need not provide prior notice or issue warnings before taking any action under this MAP Policy.
13. Distributors of SOG products will supply a copy of this MAP Policy to any new or existing Reseller for their records and/or make this available to them via website location or link.
14. This MAP Policy is solely within SOG’ discretion and may be delivered to Resellers directly by SOG and its representative or via authorized SOG Distributors. As this is a Policy between SOG and the Reseller, SOG representatives and Distributors are not authorized to make any representations, give any explanations, or otherwise communicate with Resellers about the Policy. No employee or sales representative of SOG has any authority to discuss, modify or grant exceptions to this MAP Policy. Any representation or action by any employee, sales representative or persons not specifically authorized to discuss, modify or grant exceptions to this MAP Policy under this paragraph is unauthorized and invalid. SOG does not request, and in fact discourages, any complaints by Distributors, Resellers or customers as to perceived violations of this Policy by other Resellers or Distributors. All questions about this MAP Policy should be in writing and directed via U.S. Mail to MAP Policy Administrator, SOG Specialty Knives and Tools, LLC, 6521 212th Street SW, Lynnwood, WA 98036 or via e-mail to MAPAdministrator@sogknives.com who will respond only in writing. No oral communications about this MAP Policy are authorized. The MAP Policy Administrator shall be solely responsible for determining whether a violation of the policy has occurred and for communicating decisions to Resellers regarding the policy and receiving any communications regarding sanctions imposed under this MAP Policy. Any action taken by SOG under this MAP Policy shall be without liability to SOG. This Policy is subject to change at any time by SOG in its discretion.
15. The terms of this MAP Policy are confidential and should not be disclosed to other parties. This MAP Policy has been established by SOG to help ensure the legacy of SOG as a leading brand of high performance, high quality products and to protect the reputation of its name and products. This MAP Policy is also designed to support SOG customers and consumers, and to ensure that Resellers and Distributors have the confidence and incentive to invest resources into building their business with the SOG brand.

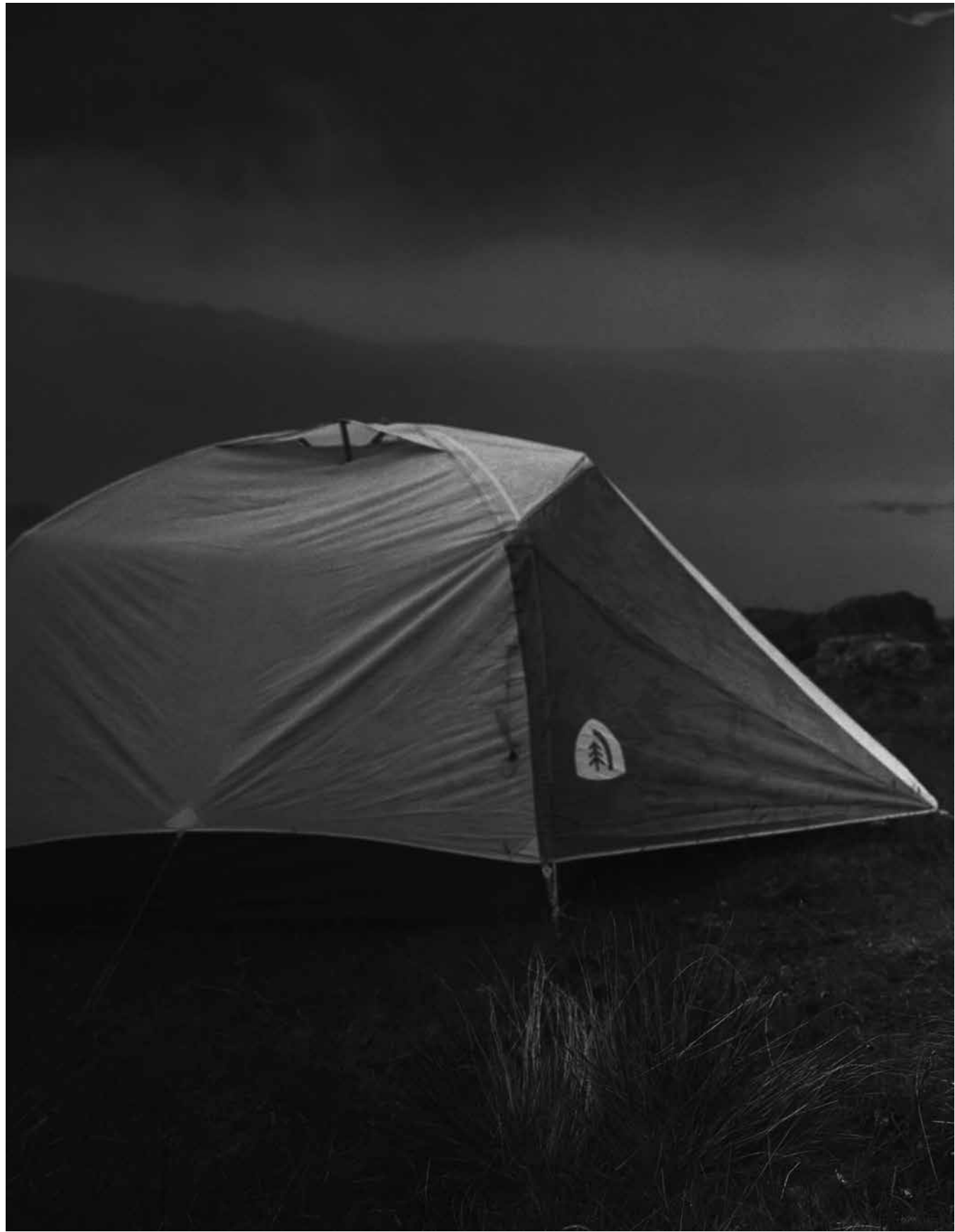



SOG

SPECIALTY KNIVES & TOOLS, LLC
6521 212TH STREET SW
LYNNWOOD, WA 98036 USA
425.771.6230
WWW.SOGKNIVES.COM

